brightit

Implant Catalog



Bone Level



Tissue Level

Dentium

Contents

Fixture

Tissue Level	3
Bone Level	7

Abutment

Abutment Procedure Line-up	11
Tissue Level Abutment	15
Bone Level Abutment	19

Overdenture

Overdenture Procedure Line-up	25
Tissue Level Overdenture	27
Bone Level Overdenture	29

Surgical Kit	31
--------------------	----



Tissue Level

Tissue Level

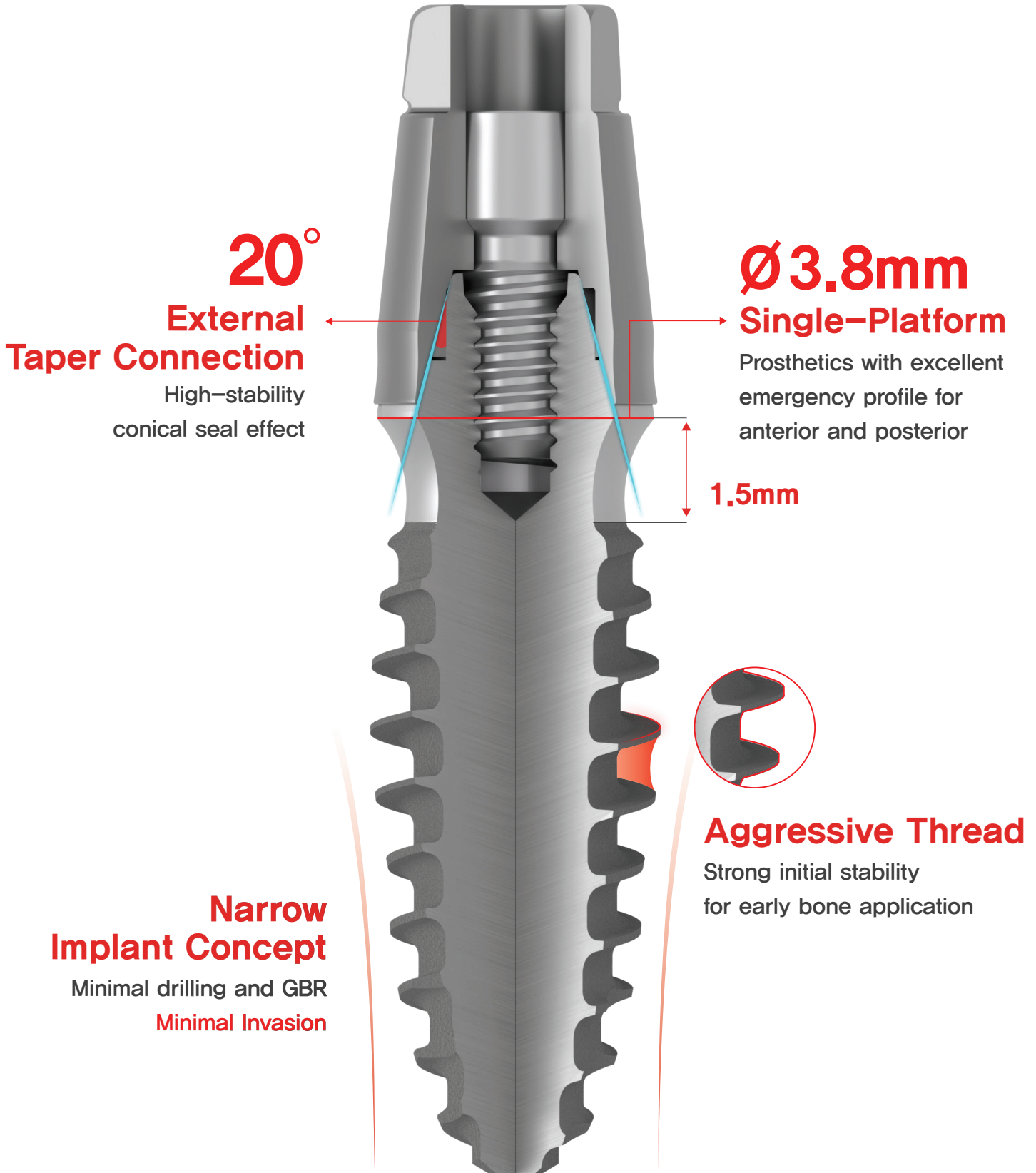

20°

External Taper Connection

High-stability
conical seal effect

Ø 3.8mm

Single-Platform

Prosthetics with excellent
emergency profile for
anterior and posterior

1.5mm

Narrow Implant Concept

Minimal drilling and GBR
Minimal Invasion



Aggressive Thread

Strong initial stability
for early bone application

High compressive strength

Small diameter implant without concern for fracturing

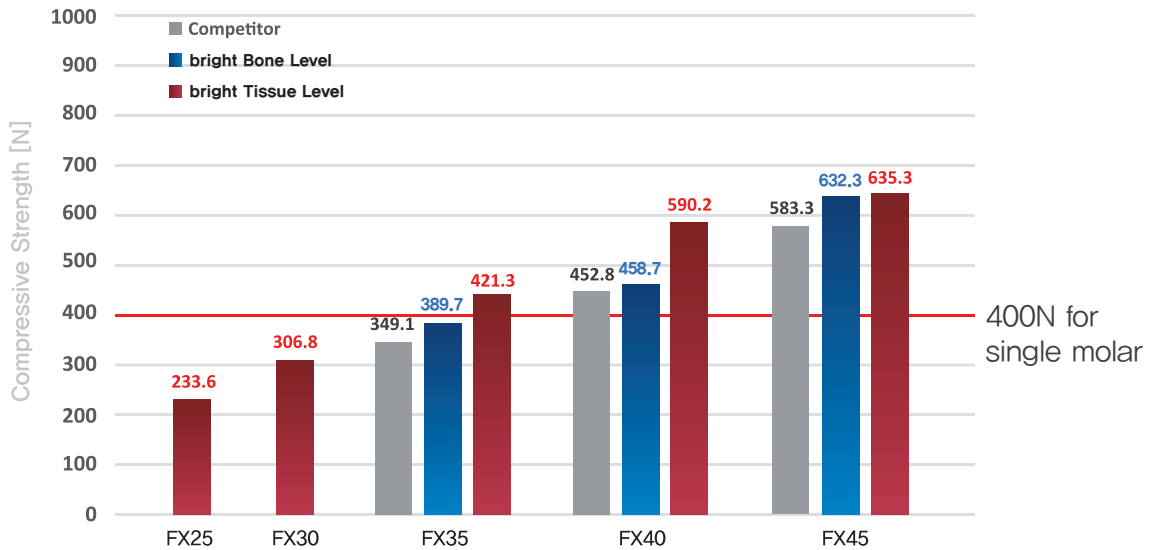

※ Caution : heavy bruxer or hard food bite

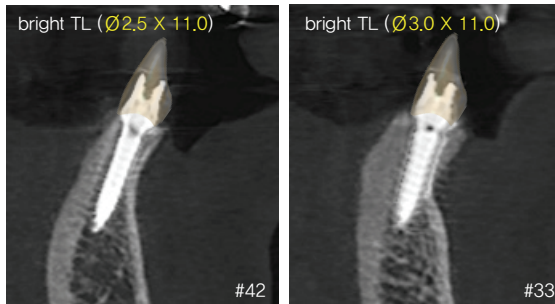

Ø2.0, 2.5, 3.0 implant can be used to anterior narrow ridge

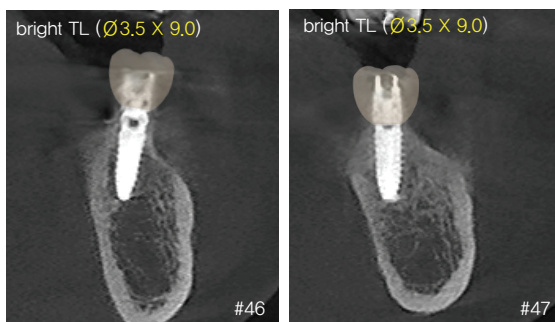

Ø3.5 implant can be used to molar area

Tissue Level Fixture Specifications

· Cover screw is not included in the package

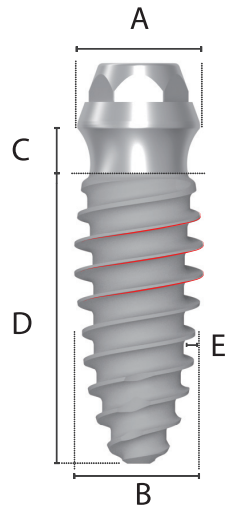

Common Feature

- **Single Platform (Ø3.8mm)**
- Gingival Height : 1.5mm
- Mountless Type

Unit: mm

Cap Color								
		Pink	Sky blue	Gray	Yellow	Green	Blue	Red
A	Platform Diameter	3.8						
B	Body Diameter	2.0	2.5	3.0	3.5	4.0	4.5	5.0
C	Gingival Height	1.5						
D	Thread Length	7.0 / 9.0 / 11.0 / 13.0 / 15.0						
E	Thread Depth	0.15	0.30	0.45	0.50	0.55	0.60	0.60

Unit : mm

Platform	Body	Thread Length	Art. No.
Ø3.8	Ø2.0	7.0	NTI382007B
		7.0	NTI382007
		9.0	NTI382009
		11.0	NTI382011
		13.0	NTI382013
		15.0	NTI382015

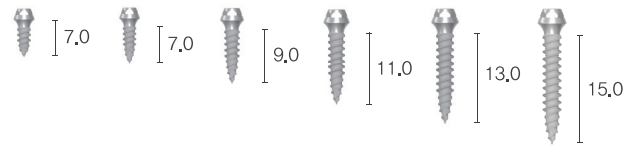

Platform	Body	Thread Length	Art. No.
Ø3.8	Ø2.5	7.0	NTI382507B
		7.0	NTI382507
		9.0	NTI382509
		11.0	NTI382511
		13.0	NTI382513
		15.0	NTI382515

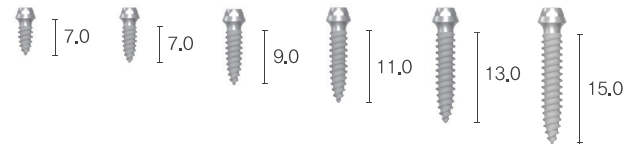

Platform	Body	Thread Length	Art. No.
Ø3.8	Ø3.0	7.0	NTI383007B
		7.0	NTI383007
		9.0	NTI383009
		11.0	NTI383011
		13.0	NTI383013
		15.0	NTI383015

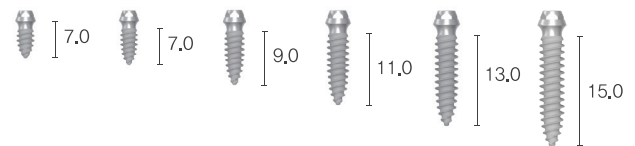

Platform	Body	Thread Length	Art. No.
Ø3.8	Ø3.5	7.0	NTI383507B
		7.0	NTI383507
		9.0	NTI383509
		11.0	NTI383511
		13.0	NTI383513
		15.0	NTI383515

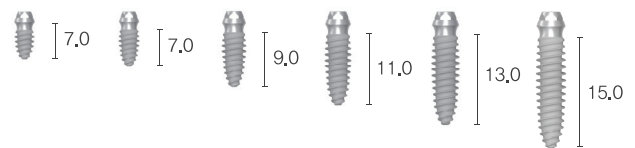

Platform	Body	Thread Length	Art. No.
Ø3.8	Ø4.0	7.0	NTI384007B
		7.0	NTI384007
		9.0	NTI384009
		11.0	NTI384011
		13.0	NTI384013
		15.0	NTI384015

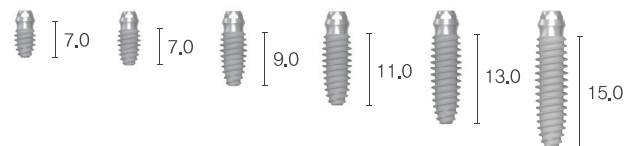

Platform	Body	Thread Length	Art. No.
Ø3.8	Ø4.5	7.0	NTI384507B
		7.0	NTI384507
		9.0	NTI384509
		11.0	NTI384511
		13.0	NTI384513
		15.0	NTI384515

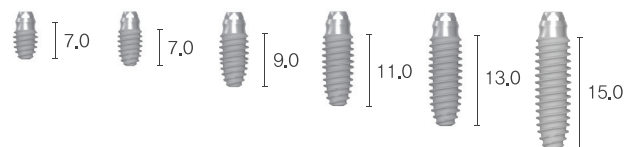

Platform	Body	Thread Length	Art. No.
Ø3.8	Ø5.0	7.0	NTI385007B
		7.0	NTI385007
		9.0	NTI385009
		11.0	NTI385011
		13.0	NTI385013
		15.0	NTI385015

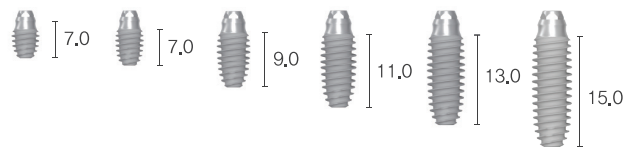

Bone Level



Deep & Strong

Fixture-Abutment Contact Area

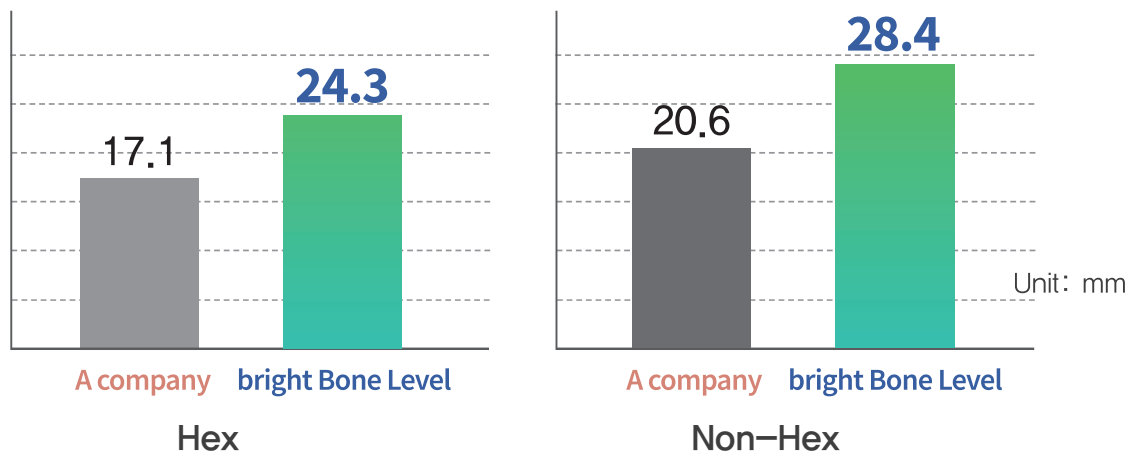

Less Sink-Down

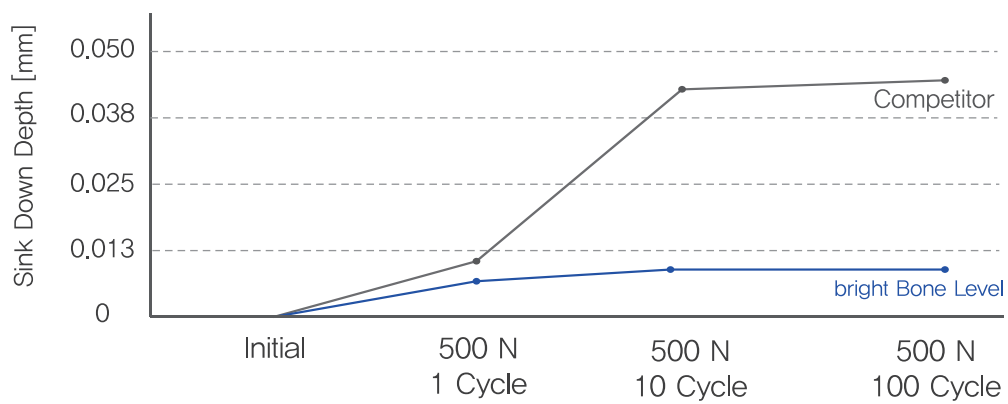

Bone Level Fixture Specifications



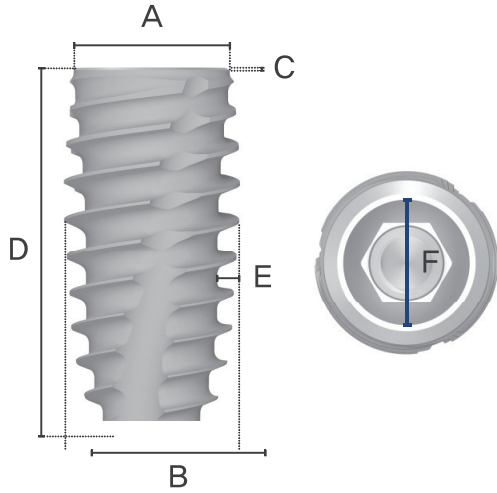

• Cover screw is not included in the package



Common Feature

- Internal Morse Taper (10°)
- Abutment Interface : 3.3mm
- Mountless Type

Unit: mm

Cap Color						
		Yellow	Green	Blue	Red	Orange
A	Platform Diameter	3.5	3.8	4.3	4.8	6.0
B	Body Diameter	3.7	4.0	4.5	5.0	5.0
C	Bevel Height	0	0.06	0.20	0.32	0.66
D	Total Length	7.0 / 9.0 / 11.0 / 13.0 / 15.0				
E	Thread Depth	0.35	0.40	0.45	0.50	0.50
F	Abutment Interface	3.3				

Unit : mm

Platform	Body	Bevel Length	Total Length	Art. No.
Ø3.5	Ø3.7	0	7.0	BFX3507BS
			7.0	BFX3507
			9.0	BFX3509
			11.0	BFX3511
			13.0	BFX3513
			15.0	BFX3515

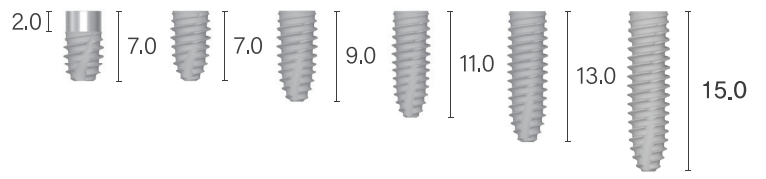

Platform	Body	Bevel Length	Total Length	Art. No.
Ø3.8	Ø4.0	0.06	7.0	BFX4007BS
			7.0	BFX4007
			9.0	BFX4009
			11.0	BFX4011
			13.0	BFX4013
			15.0	BFX4015

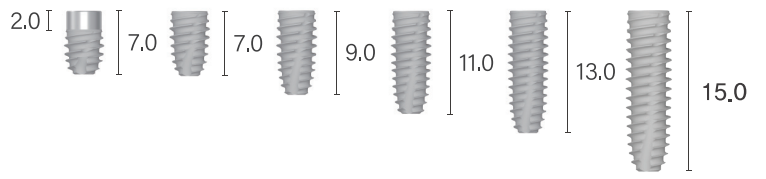

Platform	Body	Bevel Length	Total Length	Art. No.
Ø4.3	Ø4.5	0.20	7.0	BFX4507BS
			7.0	BFX4507
			9.0	BFX4509
			11.0	BFX4511
			13.0	BFX4513
			15.0	BFX4515

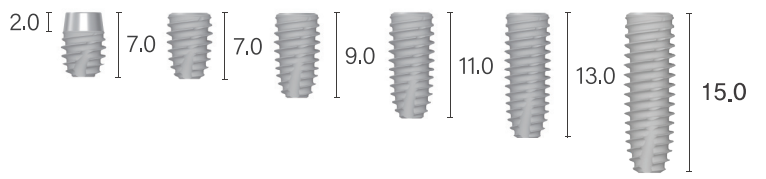

Platform	Body	Bevel Length	Total Length	Art. No.
Ø4.8	Ø5.0	0.32	7.0	BFX5007BS
			7.0	BFX5007
			9.0	BFX5009
			11.0	BFX5011
			13.0	BFX5013
			15.0	BFX5015

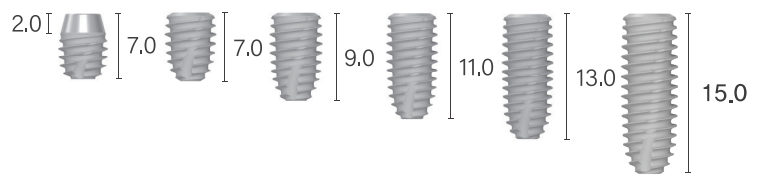

Platform	Body	Bevel Length	Total Length	Art. No.
Ø6.0	Ø5.0	0.66	7.0	BFX6007BS
			7.0	BFX6007
			9.0	BFX6009
			11.0	BFX6011
			13.0	BFX6013
			15.0	BFX6015

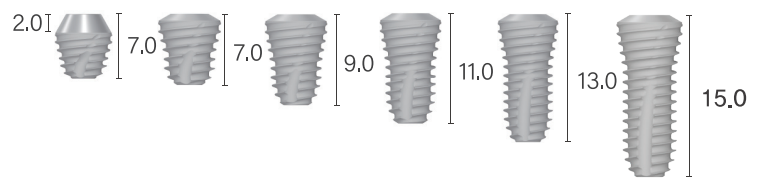

Procedure Line-up

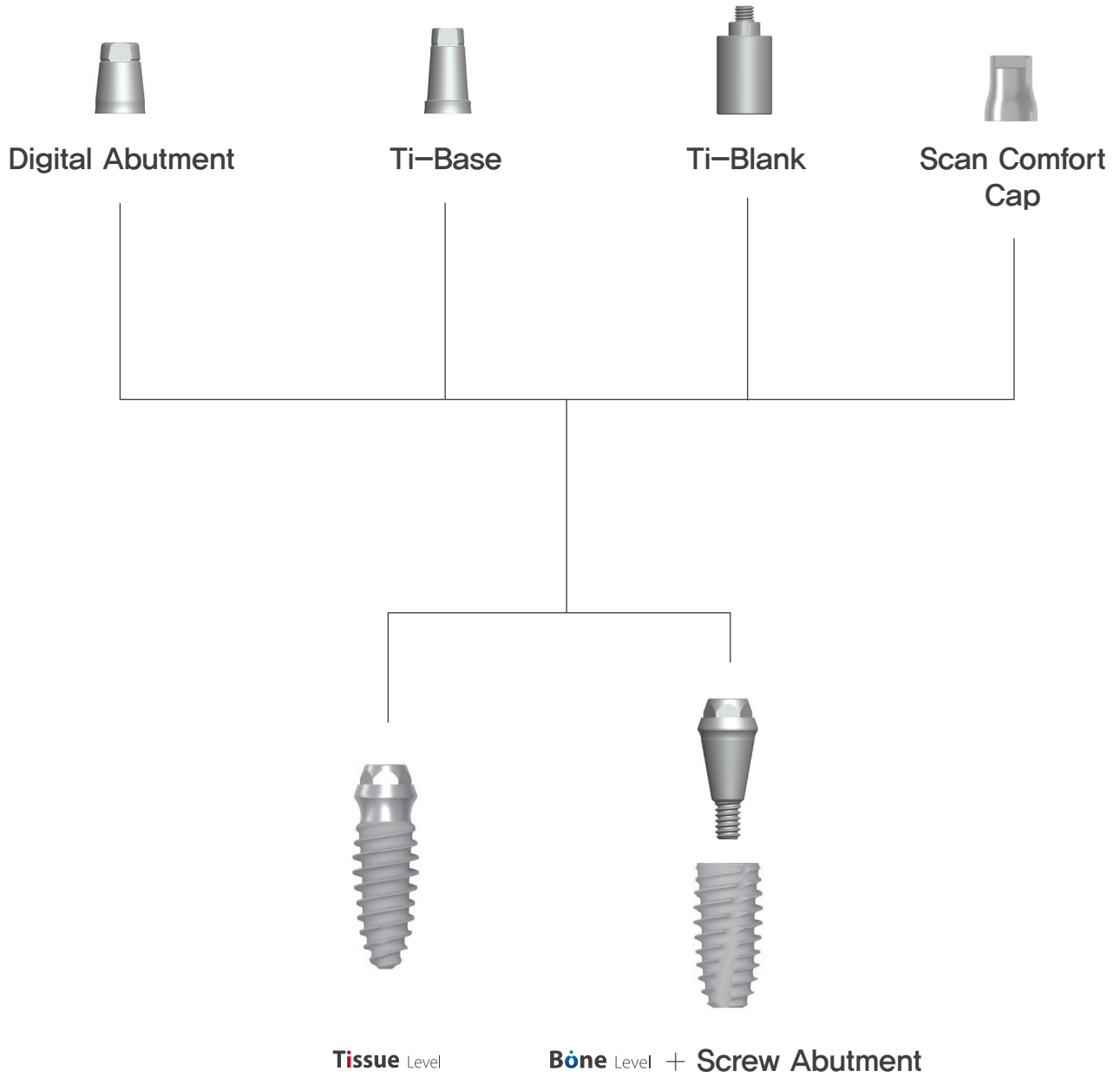

Tissue Level



Digital Abutment



Ti-Base



Healing
Abutment



Screw Abutment



Ti-Blank

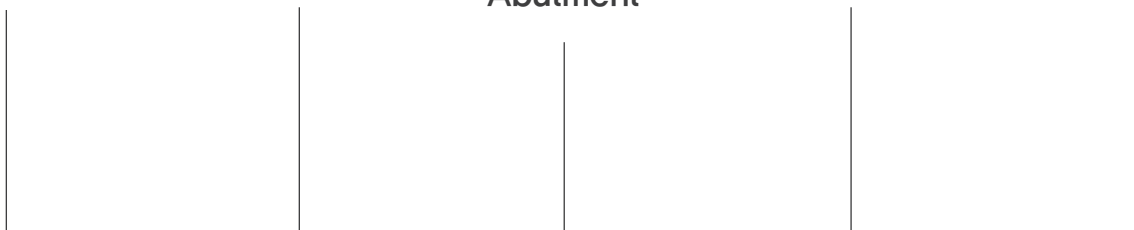

Bone Level

Bone Level

Accurate Stitching

- Digital Abutment
- Ti-Base

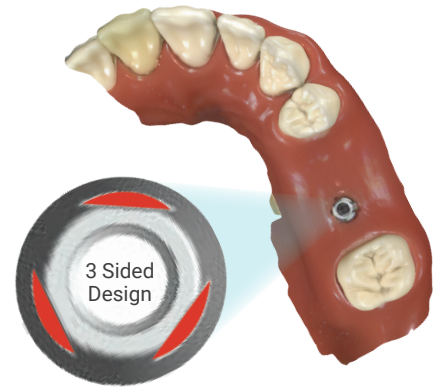
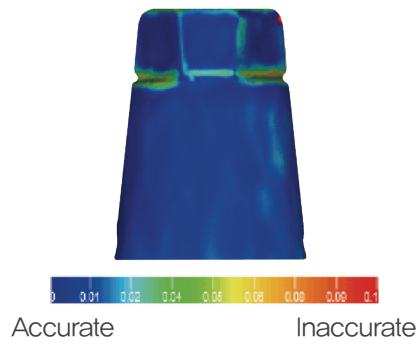

B.T.S Bite Tray Impression Scanning



Scan abutment connection

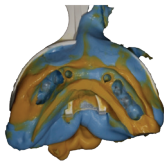

Putty + light body impression

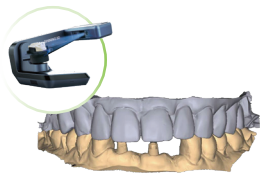

Impression with model scanner

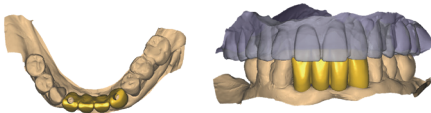

Prosthesis design



Final setting

IOS Intra Oral Scanning



Scan abutment connection

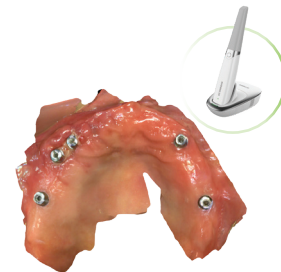

Impression with intraoral scanner



Final setting

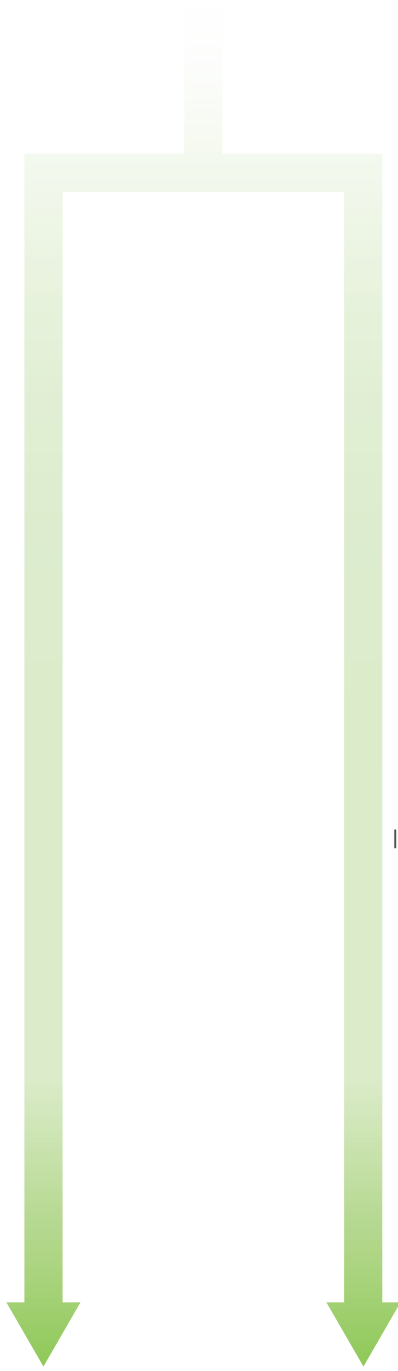

Digital Abutment

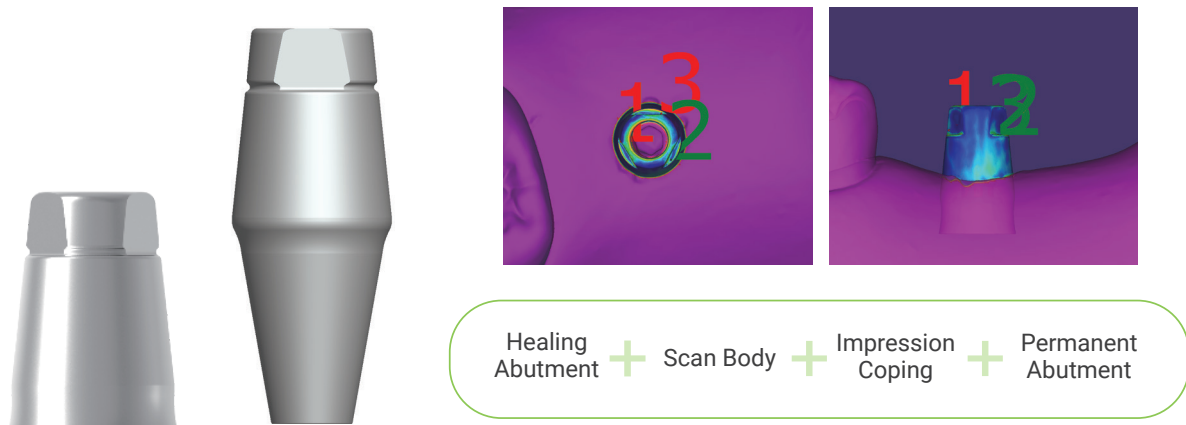

From healing to final prosthetics, it's solved with **only one abutment**

Ti – Base

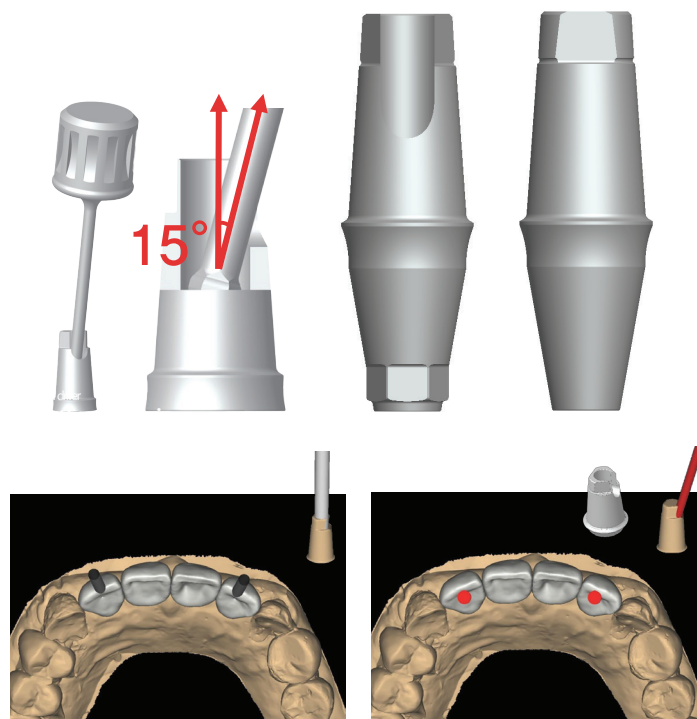

Angled hex driver allows engagement tilted up to 15°

Ti-Base

Unit: mm

Diameter	G/H	Type	Art. No.
Ø3.8	0,5	Hex	BDDC3805HO
		Non-Hex	BDDC3805NO
	1,0	Hex	BDDC3810HO
		Non-Hex	BDDC3810NO
	2,0	Hex	BDDC3820HO
		Non-Hex	BDDC3820NO
Ø5.0	1,0	Hex	BDDC5010H
		Non-Hex	BDDC5010N
	2,0	Hex	BDDC5020H
		Non-Hex	BDDC5020N

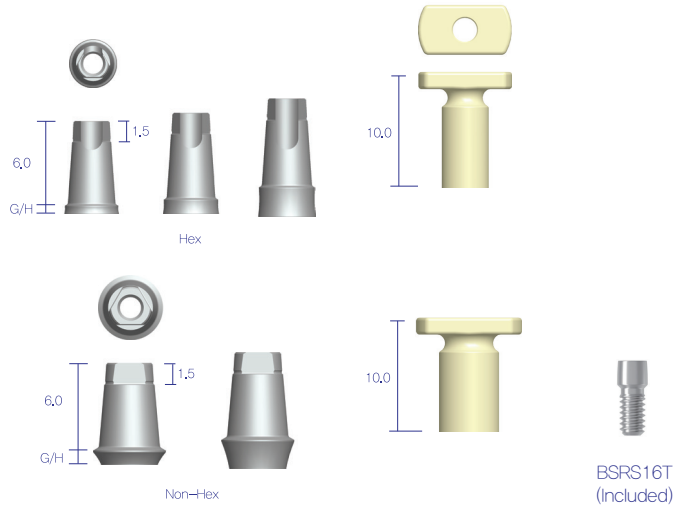

- ※ Both 'Bite Tray impression Scan' and 'Intra Oral Scan' are available
- ※ Less than 30N·cm torque to prevent screw fracture
- ※ Ø3.8 is for anterior
- ※ Ø5.0 is for posterior

Digital Abutment

Unit: mm

Diameter	Height	G/H	Type	Art. No.
Ø3.8	4,5	0,5	Hex	BDSC3805H
			Non-Hex	BDSC3805N
		1,0	Hex	BDSC3810H
			Non-Hex	BDSC3810N
		2,0	Hex	BDSC3820H
			Non-Hex	BDSC3820N
Ø5.0	4,5	1,0	Hex	BDSC5010H
			Non-Hex	BDSC5010N
		2,0	Hex	BDSC5020H
			Non-Hex	BDSC5020N

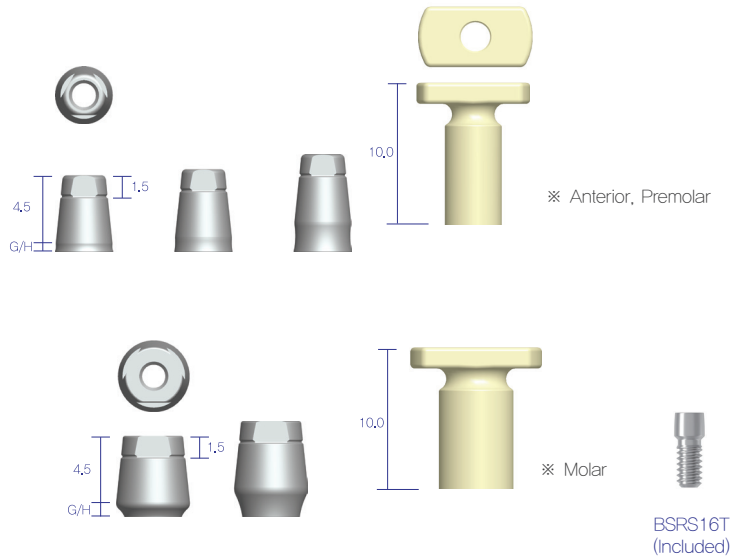

- ※ Both 'Bite Tray impression Scan' and 'Intra Oral Scan' are available
- ※ Less than 30N·cm torque to prevent screw fracture
- ※ Ø3.8 is for anterior
- ※ Ø5.0 is for posterior

Scan Comfort Cap

Unit: mm

Diameter 1	Diameter 2	Height	Type	Art. No.
4.0	3.2	4.1	Non-Hex	BISC3832NS
		5.0		BISC3832N
		8.0		BISC3832NL
	4.0	4.1		BISC3840NS
		5.0		BISC3840N
		8.0		BISC3840NL
	4.8	4.1		BISC3848NS
		5.0		BISC3848N
		8.0		BISC3848NL

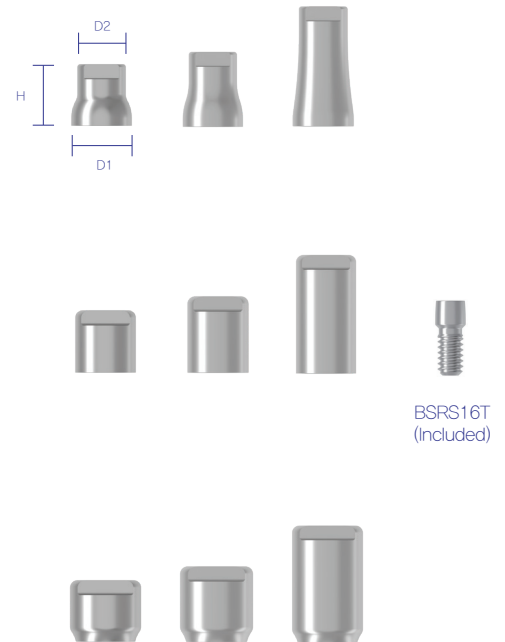

- ※ Both 'Bite Tray impression Scan' and 'Intra Oral Scan' are available
- ※ Keep the 10N·cm torque to tighten with fixture
- ※ Only non-Hex

Ti-Temporary Abutment

Unit: mm

G/H	Type	Art. No.
1.0	Hex	BSTC4510TH
3.0		BSTC4530TH

Unit: mm

G/H	Type	Art. No.
1.0	Non-Hex	BSTC4510TN
3.0		BSTC4530TN

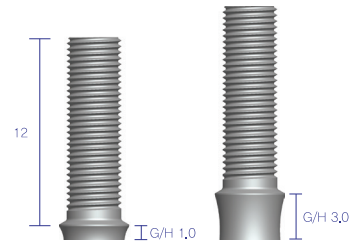
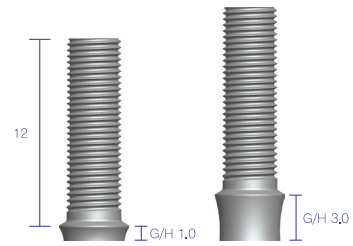

- ※ Less than 30N·cm torque is enough for screw tightening
- ※ Caution : sometimes with too much higher torque, screw can be broken

Ti-Blank

Unit: mm

Machine	Diameter	Type	Art. No.
Dentium	Ø10.0	Hex	TBTB3810H
	Ø14.0		TBTB3814H
	Ø10.0	Non-Hex	TBTB3810N
	Ø14.0		TBTB3814N

Unit: mm

Machine	Diameter	Type	Art. No.
Doowon	Ø10.0	Hex	TDTB3810H
	Ø14.0		TDTB3814H
	Ø10.0	Non-Hex	TDTB3810N
	Ø14.0		TDTB3814N

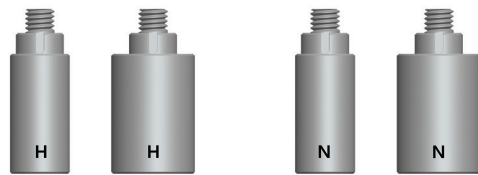

BSRS16T (Included)

- ※ After finish processing, use exclusive abutment
- ※ Diverse connection to diverse metal milling machine for custom abutment

Impression Component

Impression coping Pick-up

Unit: mm

Application	Diameter	Type	Art. No.
Ø3,8	Ø3,8	Single	BSPU3838S
		Bridge	BSPU3838B
Ø3,8	Ø5,0	Single	BSPU3850S
		Bridge	BSPU3850B

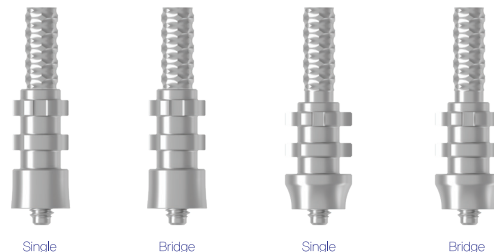

Impression coping Screw

Unit: mm

Type	Height	Art. No.
Pick-up	14,3	BSPS09



Impression coping Transfer

Unit: mm

Application	Diameter	Type	Art. No.
Ø3,8	Ø3,8	Single	BSTF3838S
		Bridge	BSTF3838B
Ø3,8	Ø5,0	Single	BSTF3850S
		Bridge	BSTF3850B

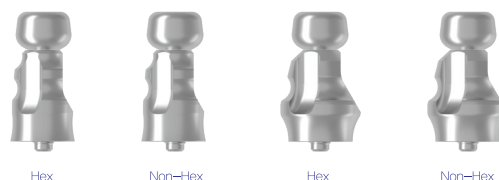

Impression coping Screw

Unit: mm

Type	Height	Art. No.
Transfer	8,7	BSTS09



Lab Analog

Unit: mm

Diameter	Height	Art. No.
Ø3,8	12,0	BSDAN

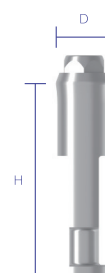

Ti-Base

Unit: mm

Diameter	G/H	Type	Art. No.
Ø3.8	1.5	Hex	BDDA3815HO
		Non-Hex	BDDA3815N
	2.5	Hex	BDDA3825HO
		Non-Hex	BDDA3825N
	3.5	Hex	BDDA3835HO
		Non-Hex	BDDA3835N
Ø5.0	2.5	Hex	BDDA5025H
		Non-Hex	BDDA5025N
	3.5	Hex	BDDA5035H
		Non-Hex	BDDA5035N

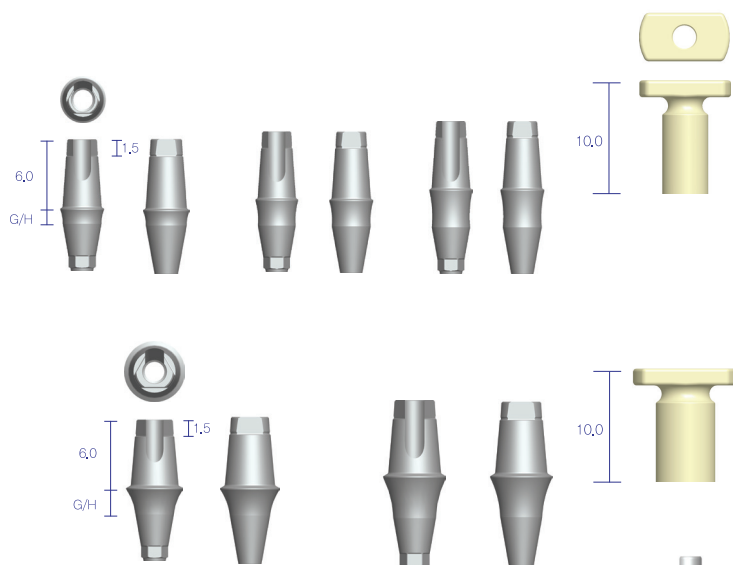

- ※ Both 'Bite Tray impression Scan' and 'Intra Oral Scan' are available
- ※ Less than 30N-cm torque to prevent screw fracture
- ※ Ø3.8 is for anterior
- ※ Ø5.0 is for posterior

BASC1619
(Included)

Digital Abutment

Unit: mm

Diameter	G/H	Type	Art. No.
Ø3.8	1.0	Hex	BDS3810H
		Non-Hex	BDS3810N
	2.0	Hex	BDS3820H
		Non-Hex	BDS3820N
	3.0	Hex	BDS3830H
		Non-Hex	BDS3830N
Ø5.0	2.0	Hex	BDS5020H
		Non-Hex	BDS5020N
	3.0	Hex	BDS5030H
		Non-Hex	BDS5030N

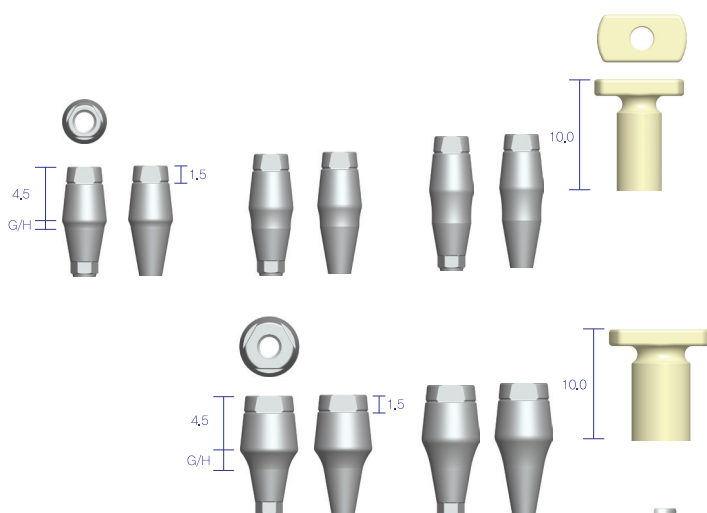

- ※ Both 'Bite Tray impression Scan' and 'Intra Oral Scan' are available
- ※ Less than 30N-cm torque to prevent screw fracture
- ※ Ø3.8 is for anterior
- ※ Ø5.0 is for posterior

BASC1619
(Included)

Healing Component

Cover Screw

Unit: mm

Diameter	Art. No.
Ø3.6	BCS36



Healing Abutment

Unit: mm

Diameter	Height	G/H	Art. No.
Ø 3.8	2.5	1.5	BHAB381525
	5.5	2.5	BHAB382555
	8.5	3.5	BHAB383585
Ø 5.0	2.5	1.5	BHAB501525
	5.5	2.5	BHAB502555
	8.5	3.5	BHAB503585
Ø 6.2	2.5	1.5	BHAB621525
	5.5	2.5	BHAB622555
	8.5	3.5	BHAB623585

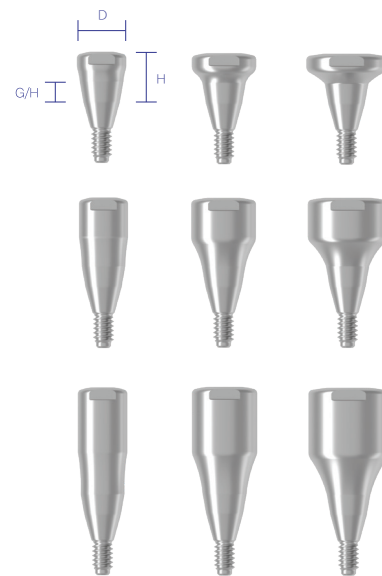

- ※ Use no more than 10 N-cm of torque when screwing Healing Abutment to a fixture
- ※ If hex is worn, slot on the head of the product can be used to rotate it
- ※ Non-Hex healing abutment can be used for 'Bite Tray impression' and 'Intra Oral Scan'

Screw Abutment

Unit: mm

Diameter	G/H	Art. No.
Ø3.8	1.0	BSA3810
	2.0	BSA3820
	3.0	BSA3830

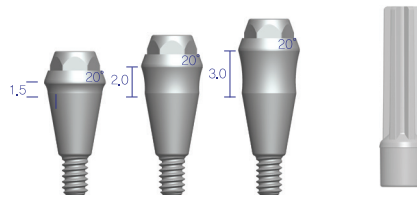

※ Less than 20N-cm torque is enough for screw tightening

Angled Screw Abutment

Unit: mm

Diameter	Angle	G/H	Type	Art. No.
Ø3.8	15°	1.0	Hex	BASA381510H
		2.0		BASA381520H
		3.0		BASA381530H
		1.0	Non-Hex	BASA381510N
		2.0		BASA381520N
		3.0		BASA381530N

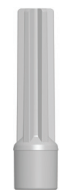

BASC1619 (Included)

※ Less than 20N-cm torque to prevent screw fracture

※ Non-hex angled screw abutment due to 10° deep and broad connection to prevent rotation

Ti-Temporary Abutment

Unit: mm

G/H	Type	Art. No.
1.0	Non-Hex	BTA4510TN
3.0		BTA4530TN

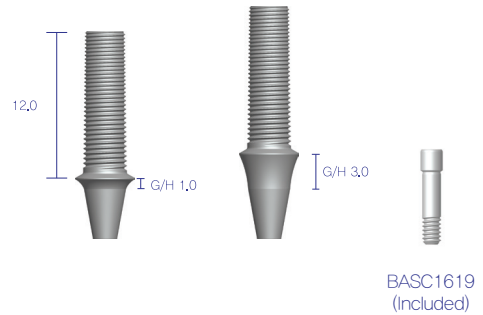

- ※ Less than 20N·cm torque is enough for screw tightening
- ※ Caution : sometimes with too much higher torque, screw can be broken

Ti-Blank

Unit: mm

Machine	Diameter	Type	Art. No.
Dentium	Ø 10.0	Hex	BXTB10H
	Ø 14.0		BXTB14H
	Ø 10.0	Non-Hex	BXTB10N
	Ø 14.0		BXTB10N

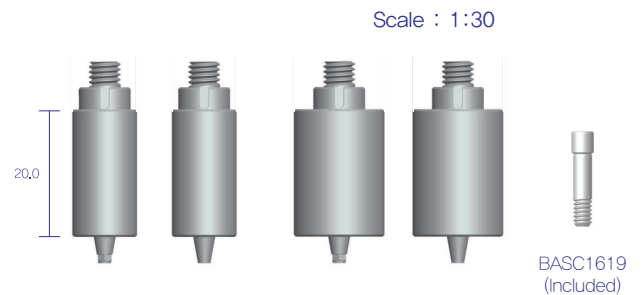

- ※ After finish processing, use exclusive abutment
- ※ Diverse connection to diverse metal milling machine for custom abutment

Impression Component

Pick-up Type [Hex]

Unit: mm

Diameter	Type	a	b	Art. No.
Ø3.8	Middle	20,0	13,0	BDPU3813H
	Long	22,0	16,0	BDPU3816H
Ø5.0	Short	18,0	12,0	BDPU5012H
	Long	22,0	15,0	BDPU5015H

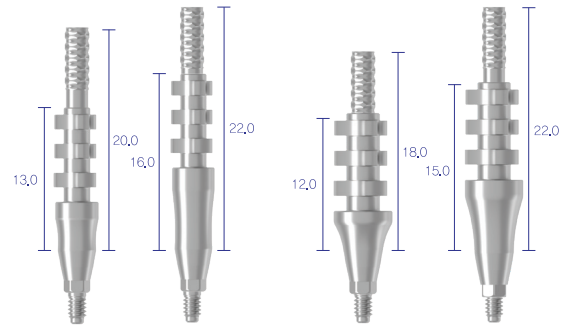

Transfer Type [Non-Hex]

Unit: mm

Diameter	Type	a	Art. No.
Ø3.8	Middle	13,0	BDTF3813N
	Long	16,0	BDTF3816N
Ø5.0	Short	12,0	BDTF5012N
	Long	15,0	BDTF5015N

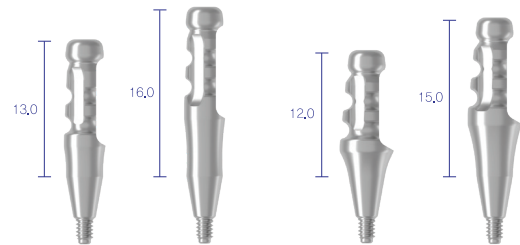

Pick-up Screw

Unit: mm

Height	Art. No.
24,2	BDPS11
26,2	BDPS13
28,2	BDPS15

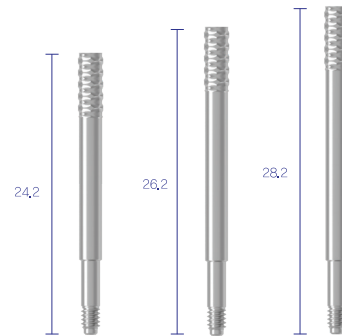

Lab Analog

Unit: mm

Diameter	Height	Art. No.
Ø4.0	12,0	BDAN

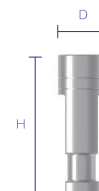

Narrow Tissue Level



Short Bone Level

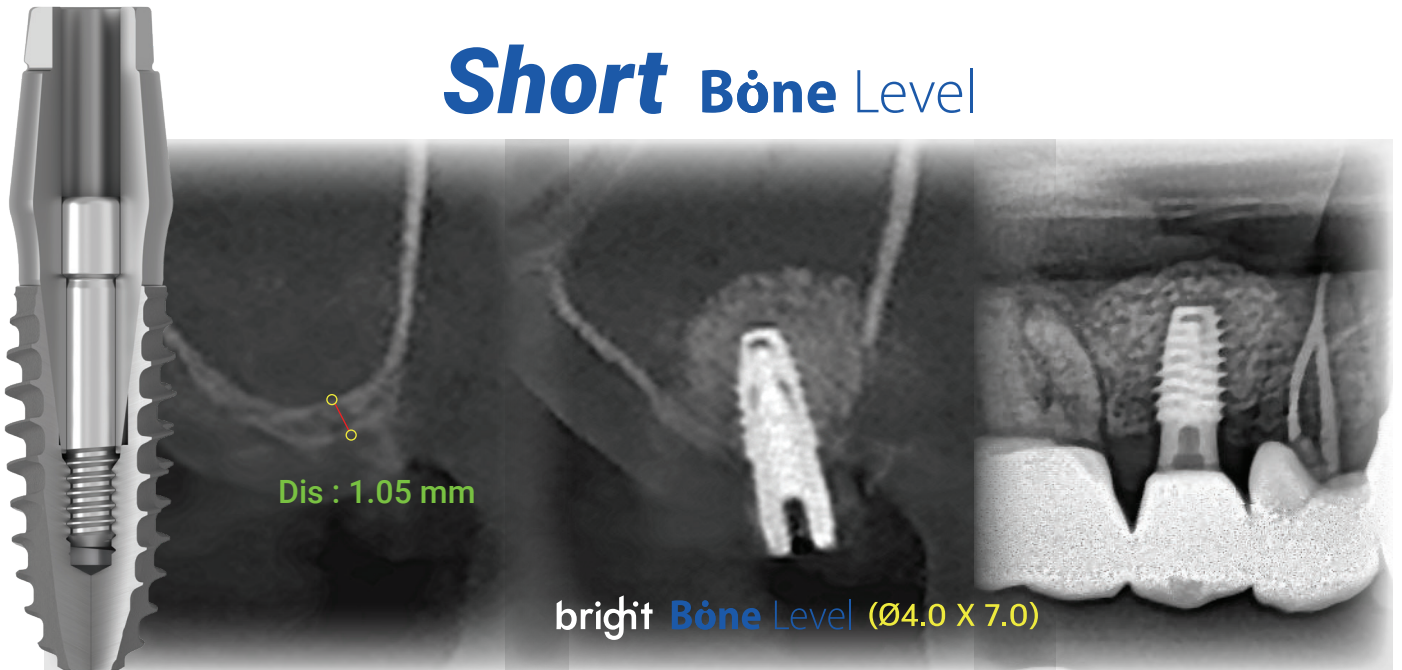

Good News



Dentiumworld



Dentium Seminar



bright Mall

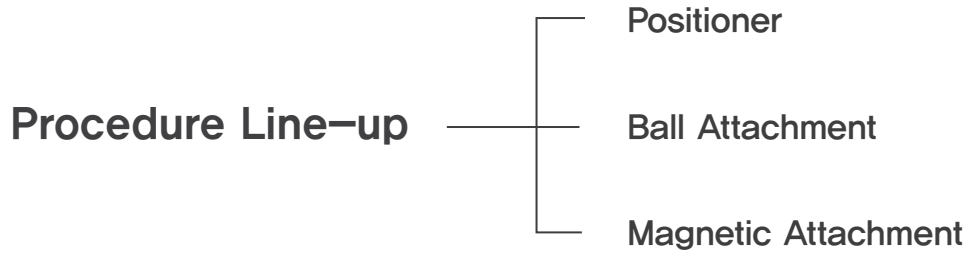

Metal/Plastic Socket



Positioner Abutment



O-Ring Type



Ball Abutment



Magnet Assay
(Dome Type)



Implant Keeper
(Dome Type)



Magnet Assay
(Flat Type)



Implant Keeper
(Flat Type)



Tissue Level

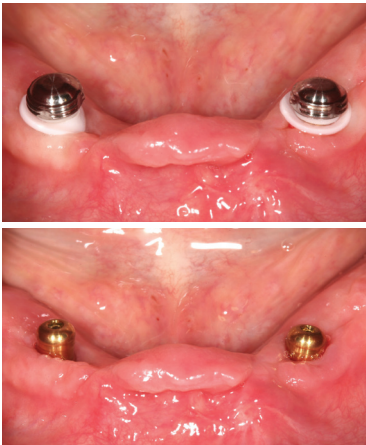

Positioner

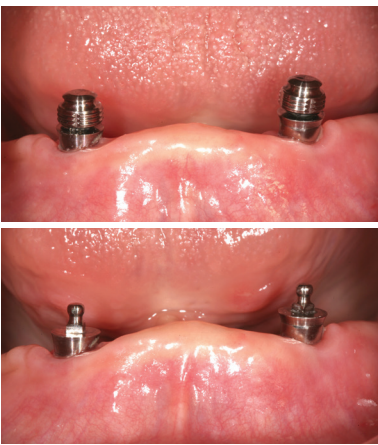

Ball Attachment



Magnetic Attachment



Metal/Plastic Socket



O-Ring Type



Magnet Assay
(Dome Type)



Magnet Assay
(Flat Type)



Positioner Abutment



Ball Abutment



Implant Keeper
(Dome Type)



Implant Keeper
(Flat Type)



Bone Level

Overdenture Component

Tissue Level

Positioner Abutment

Unit: mm

Diameter	G/H	Art. No.
Ø3.6	1.3	BPC3613
	2.3	BPC3623
	3.3	BPC3633



Positioner Metal Socket



FSMH

Positioner Plastic Socket



MSOP
100gf

MSLP
300gf

MSMP
500gf

MSHP
1000gf

Ball Abutment (Ø1.8 Ball)

Unit: mm

Diameter	G/H	Art. No.
Ø3.8	1.5	BSBC18



Socket Spacer

Diameter	Art. No.
Ø4.05	GBIC3L
Ø4.85	GBIC2L



Female Socket / O-ring

Diameter	Retention Force	Art. No.
Ø4.05	300~500gf	BPF3
Ø4.85	500~700gf	BPF2



Implant Keeper (Dome Type)

Diameter	G/H	Art. No.
Ø5.5	3.5	BSMK5535D
	4.5	BSMK5545D
	5.5	BSMK5555D

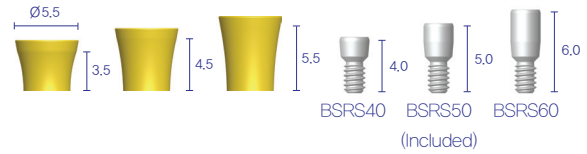

Implant Keeper (Flat Type)

Unit: mm

Diameter	G/H	Art. No.
Ø4.2	3.0	BSMK4230S
	4.0	BSMK4240S
	5.0	BSMK4250S

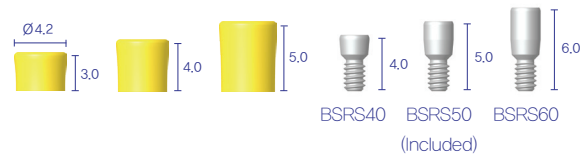

Magnet Assay (Dome Type)

Unit: mm

Diameter	H	Art. No.
Ø5.0	2.5	BMGT5025D



Magnet Assay (Flat Type)

Unit: gf

Diameter	Power	Art. No.
Ø4.2	400	XMG4240
	600	XMG4260

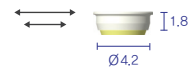

Length difference between Diameters
minimize sink-down
 even if the back of denture subsides

Overdenture Component

Bone Level

Positioner Abutment

Unit: mm

Diameter	G/H	Art. No.
Ø3.6	0.5	BPAB3605
	1.0	BPAB3610
	2.0	BPAB3620
	3.0	BPAB3630
	4.0	BPAB3640
	5.0	BPAB3650

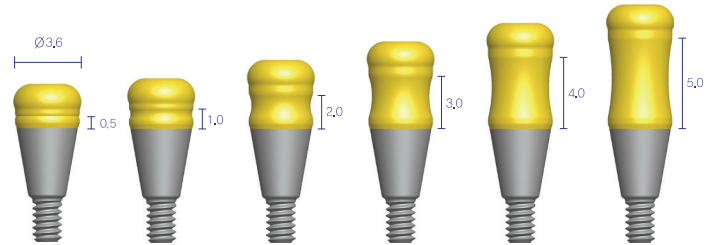

Positioner Metal Socket



FSMH

Positioner Plastic Socket



MSOP
100gf

MSLP
300gf

MSMP
500gf

MSHP
1000gf

Ball Abutment

Unit: mm

Diameter	G/H	Art. No.
Ø3.8	0.5	BBAB380518
	1.0	BBAB381018
	2.0	BBAB382018
	3.0	BBAB383018
	4.0	BBAB384018
	5.0	BBAB385018

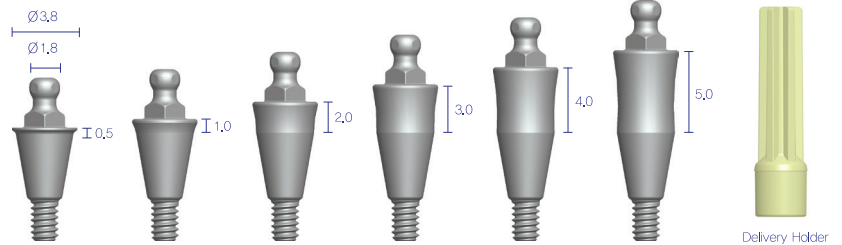

Socket Spacer

Diameter	Art. No.
Ø4.05	GBIC3L
Ø4.85	GBIC2L



Female Socket

Diameter	Retention Force	Art. No.
Ø4.05	300~500gf	BPF3
Ø4.85	500~700gf	BPF2

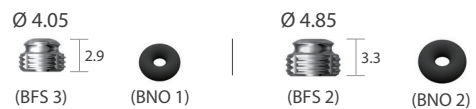

Implant Keeper (Dome Type)

Unit: mm

Diameter	G/H	Art. No.
Ø5.0	1.0	BMK5010D
	2.0	BMK5020D
	3.0	BMK5030D
	4.0	BMK5040D
	5.0	BMK5050D

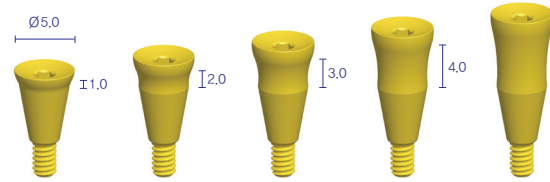

Implant Keeper (Flat Type)

Unit: mm

Diameter	G/H	Art. No.
Ø4.2	1.0	BMK4210S
	2.0	BMK4220S
	3.0	BMK4230S
	4.0	BMK4240S
	5.0	BMK4250S

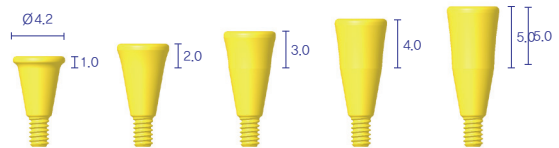

Magnet Assay (Dome Type)

Unit: mm

Diameter	H	Art. No.
Ø5.0	2.5	BMGT5025D

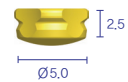

Magnet Assay (Flat Type)

Unit: gf

Diameter	Power	Art. No.
Ø4.2	400	XMG4240
	600	XMG4260

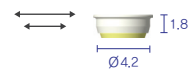

Length difference between Diameters
minimize sink-down
 even if the back of denture subsides

Surgical Lindemann Kit

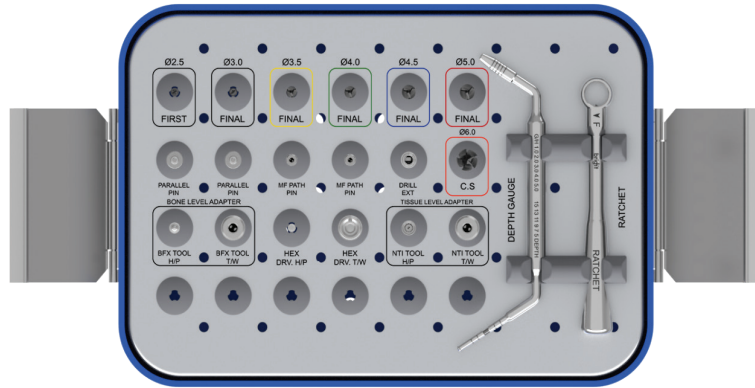

Kit Includes

BSLK

Guide Drill



Final Drill

Parallel Pin

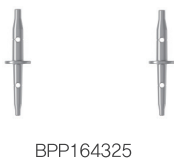

Path Pin



Drill Extension



Depth Gauge Ratchet



Bone Level Adapter



Hex Driver



Tissue Level Adapter



151311975



Guide Drill

Unit: mm

Diameter 1	Diameter 2	Length	Art. No.
Ø2.00	Ø1.40	29.0	BGD2529
		31.0	BGD2531
		33.0	BGD2533

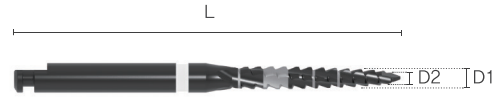

※ Note : drill speed 1,000rpm, 30~45N·cm with irrigation

1311975 0.7



Final Drill

Unit: mm

Diameter 1	Diameter 2	Length	Art. No.
Ø2.40	Ø2.00	29.0	BFD3029
		31.0	BFD3031
		33.0	BFD3033
Ø3.25	Ø2.50	29.0	BFLD3529
		31.0	BFLD3531
		33.0	BFLD3533
Ø3.55	Ø3.25	29.0	BFLD4029
		31.0	BFLD4031
		33.0	BFLD4033
Ø4.20	Ø3.55	29.0	BFLD4529
		31.0	BFLD4531
		33.0	BFLD4533
Ø4.65	Ø4.20	29.0	BFLD5029
		31.0	BFLD5031
		33.0	BFLD5033

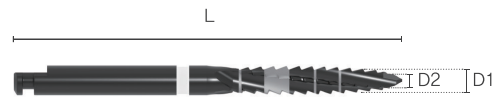

※ Note : drill speed 50rpm, 70N·cm without irrigation or drill speed 1,000rpm, 30~45N·cm with irrigation
 ※ Efficient drilling design for apical & lateral grinding

Countersink Drill

Unit: mm

Diameter 1	Diameter 2	Length	Art. No.
Ø6.40	Ø4.30	27.0	BCS6027L

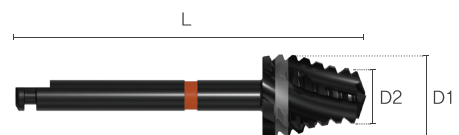

※ Note : countersink drill speed 20~60rpm, 30~45 N·cm without irrigation

Fixture Adapter for Bone Level

Unit: mm

Type	Length	Art. No.
Hand-Piece	27,0	BFA27H
	30,0	BFA30H
	32,0	BFA32H

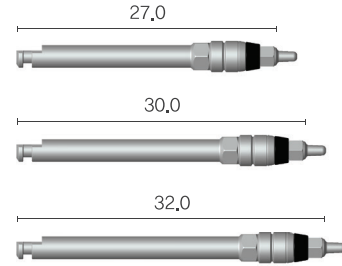

Fixture Adapter for Bone Level

Unit: mm

Type	Length	Art. No.
Ratchet	21,0	BFA21W
	24,0	BFA24W
	26,0	BFA26W
	29,0	BFA29W

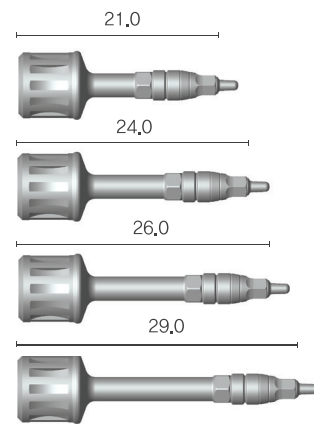

Parallel Pin

Unit: mm

Diameter 1	Diameter 2	Length	Art. No.
Ø2.0	Ø1.6	25,0	BPP164325

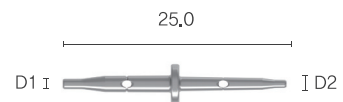

Path Pin

Unit: mm

Length	Art. No.
18,2	BFPP



Hex Driver

Unit: mm

Type	Length	Art. No.
Hand-Piece	25,0	BHD25H
Ratchet	17,0	BHD17W
	25,0	BHD25W
	27,0	BHD27W

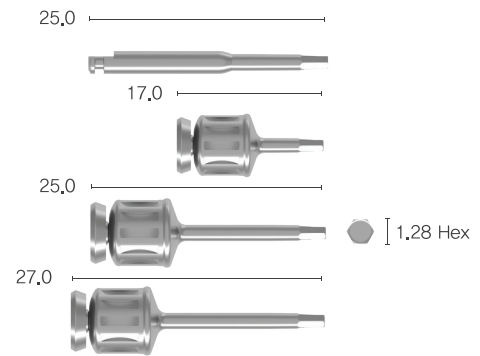

15° Angled Hex Driver

Unit: mm

Type	Length	Art. No.
Hand-Piece	25,0	BAHD25H
Ratchet	27,0	BAHD27W

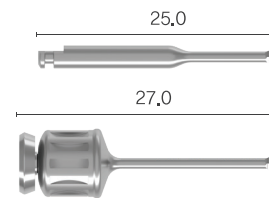

※ Note : This angled hex driver is able to tighten up to 25 degrees

Fixture Adapter for Tissue Level

Unit: mm

Diameter	Type	Length	Art. No.
Ø3.8	Hand-Piece	21,0	BSA3821H
		24,0	BSA3824H
		27,0	BSA3827H
	Ratchet	21,0	BSA3821W
		24,0	BSA3824W
		27,0	BSA3827W

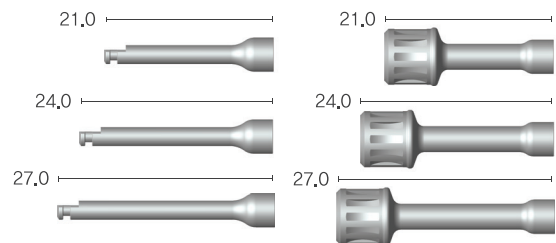

※ Enable to Screw Abutment driver

Drill Extension

Unit: mm

Length	Art. No.
26,0	BDE

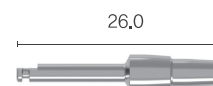

Ratchet

Unit: mm

Art. No.
BRCT



Torque Wrench

Unit: mm

Art. No.
BTW

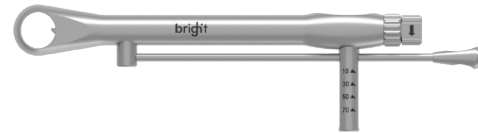

Depth Gauge

Unit: mm

Art. No.
BDG

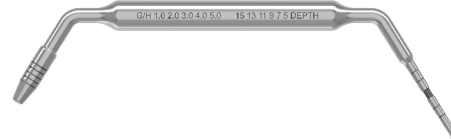

※ Note : One side of Depth Gauge measures the osteotomy depth and the other side measures the gingival height from the top of the implant

Guide Lindemann Kit

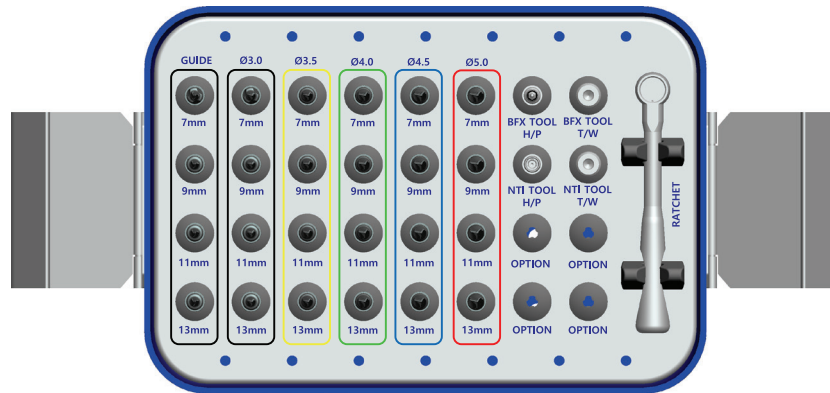

※ Efficient drilling design for apical & lateral grinding

Kit Includes

BGLK

Guide Drill



FX30 Final Drill



FX35 Final Drill



Ratchet



BRCT

FX40 Final Drill



FX45 Final Drill



FX50 Final Drill



Bone Level
Fixture Adapter

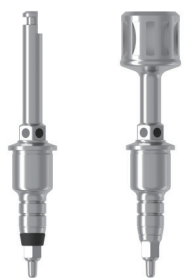

Tissue Level
Fixture Adapter



First Drill

Unit: mm

Diameter 1	Diameter 2	Length	Art. No.
Ø2.00	Ø1.40	7.0	BFGD2507L
		9.0	BFGD2509L
		11.0	BFGD2511L
		13.0	BFGD2513L

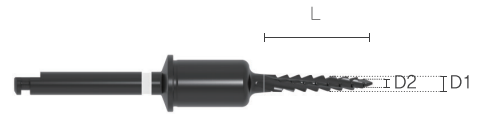

Final Drill

Unit: mm

Diameter	Length	Art. No.
Ø2.40	7.0	BFFD3007L
	9.0	BFFD3009L
	11.0	BFFD3011L
	13.0	BFFD3013L
Ø3.15	7.0	BFFD3507L
	9.0	BFFD3509L
	11.0	BFFD3511L
	13.0	BFFD3513L
Ø3.45	7.0	BFFD4007L
	9.0	BFFD4009L
	11.0	BFFD4011L
	13.0	BFFD4013L
Ø4.10	7.0	BFFD4507L
	9.0	BFFD4509L
	11.0	BFFD4511L
	13.0	BFFD4513L
Ø4.55	7.0	BFFD5007L
	9.0	BFFD5009L
	11.0	BFFD5011L
	13.0	BFFD5013L

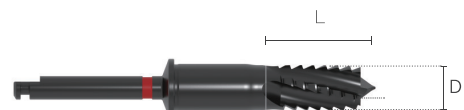
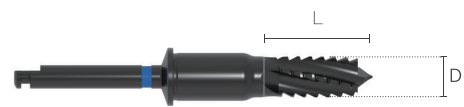
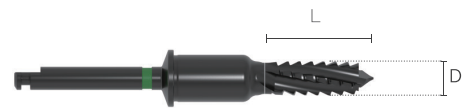
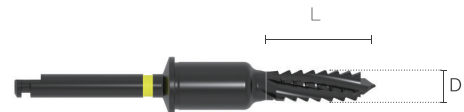
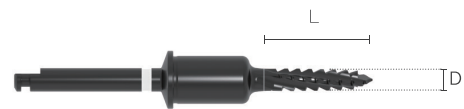

Fixture Adapter for Bone Level

Unit: mm

Type	Length	Art. No.
Hand-piece	29,0	BFFA28H
Ratchet		BFFA28W

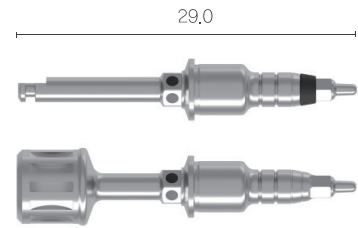

Fixture Adapter for Tissue Level

Unit: mm

Type	Length	Art. No.
Hand-piece	25,0	BFSA25H
Ratchet		BFSA25W

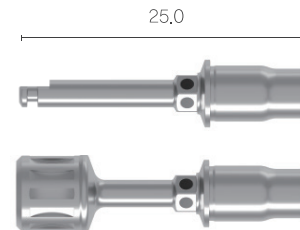

Simple Drilling Sequence

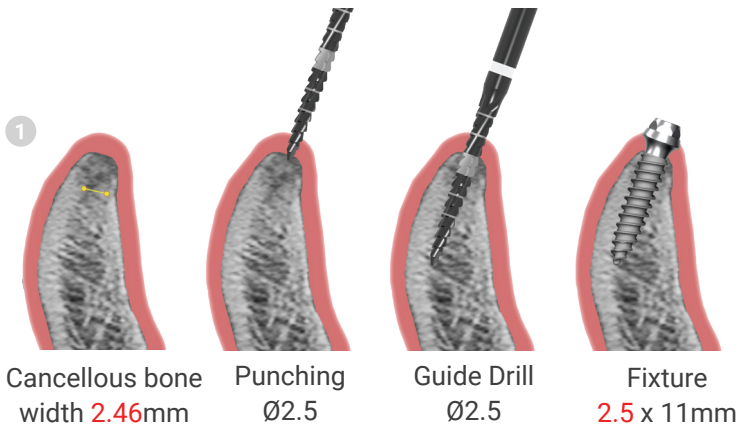

New Drilling Concept
 Drill and fixture insertion into **only cancellous** space

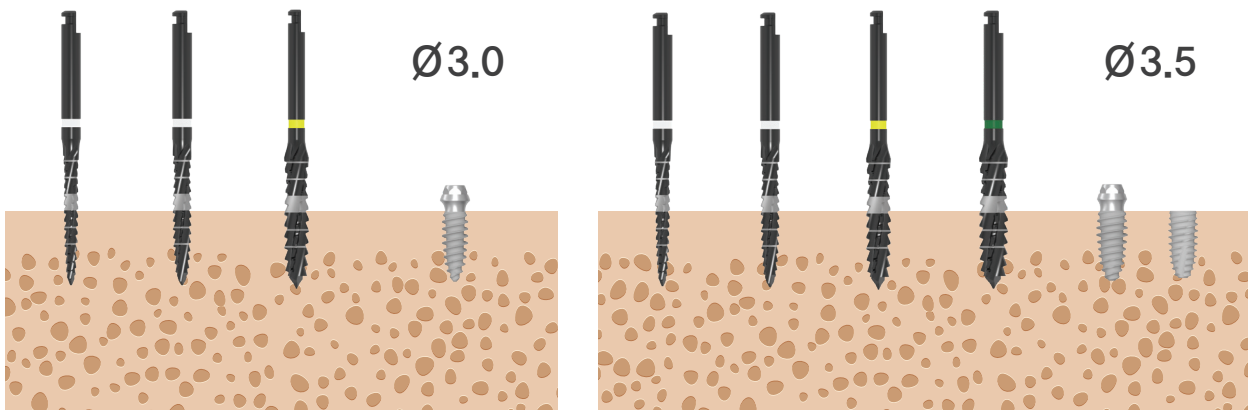
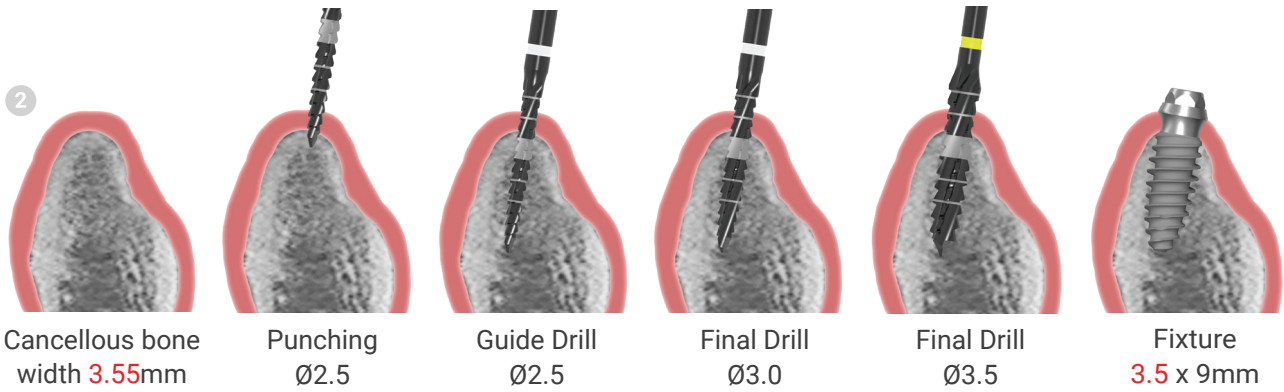

Bone Quality

	BGD25	BFD30	BFLD35	Ø3.0 Fixture	BGD25	BFD30	BFLD35	BFLD40	Ø3.5 Fixture
Soft	●				●	●			
Normal	●	●		Implant Fixation	●	●	●		Implant Fixation
Hard	●	●	●		●	●	●	●	

- : Drilling in the full length of fixture height
- ◐ : Drilling in the half length of fixture height

Dentium

bright

Bone Level **Tissue** Level

This publication is for international distribution. It may differ from the certification and sales products in some countries.

Dentium

76, Changnyong-daero 256beon-gil, Yeongtong-gu, Suwon-si, Gyeonggi-do, Republic of Korea
www.globaldentium.com **DENTIUM Co., Ltd**

