

# bright Alone

Treatment Alone



Dentium

# Introduction

## Treatment Alone

Treatment is possible alone through the suction cradle and auxiliary lighting



## Stable Structure

Floor Mount Type improves durability and efficiently operate a complex office space



## New concept of hygiene management

Detachable spittoon is possible to autoclaving, easy to maintain hygiene condition



Detachable spittoon



Replaceble instrument holder  
\* Oval Type Only



Cleaning system for water pipe  
\* Option





## Maximized Space Efficiency

Compact size is able to use space as efficiently as possible

### bright Alone

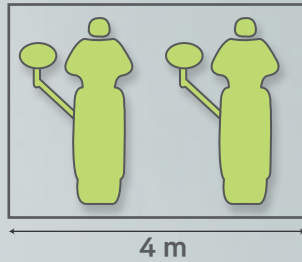

### Competitor

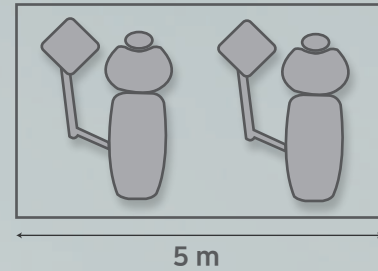

## Ergonomic design makes patient comfortable

The slim bed sheet with an ergonomic design provides maximum comfort. Able to hold the patient in position as the chair moves.



Comfortable like as lying down on the bed

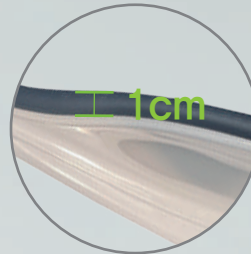

Slim sheet is tightly joined to human body



Able to secure Operator's space

## Slim plumbing with automatic suction system \*Option

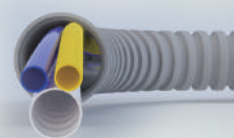

Get the best interior design with tiny size of plumbing pipe



Ø18 mm

## Option Line-up

### Dr. table

Table Type	Oval Type	Square Type
Table	 330 x 215	 400 x 275
Instrument	<b>4 Holder</b> High handpiece 1ea Low handpiece 1ea Scaler 1ea 3way syringe 1ea	<b>5 Holder</b> High handpiece 2ea Low handpiece 1ea Scaler 1ea 3way syringe 1ea

### Dental Light



LED dental light provides semipermanent service life and eye-friendly brightness

### Foot Control



Disc Type



Function Type

### Seat Color



Indigo Navy



Dark Cyan













Ocean Blue



Mocha Brown

# Instrument Line up (Basic)

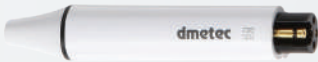
High Handpiece	Low Handpiece	Coupling
 <p><b>M800L(NSK) Optic</b></p> <ul style="list-style-type: none"> <li>Power: 23W</li> <li>Speed: 380,000~450,000min<sup>-1</sup></li> <li>Head Size: ø 10.6 x H12.4 mm</li> </ul>  <p><b>M900L(NSK) Optic</b></p> <ul style="list-style-type: none"> <li>Power: 26W</li> <li>Speed: 325,000~430,000min<sup>-1</sup></li> <li>Head Size: ø 10.8 x H12.1 mm</li> </ul>	   <p><b>FX205 M4/FX65/FX25(NSK) Non-Optic</b></p> <ul style="list-style-type: none"> <li>Midwest 4 hole · Max: 25,000 min<sup>-1</sup></li> </ul>	 <p><b>PTL-CL-LED(NSK) Optic</b></p> <ul style="list-style-type: none"> <li>stainless steel body · Titanium coating · LED coupling</li> </ul>  <p><b>KCL-LED(NSK) Optic</b></p> <ul style="list-style-type: none"> <li>For KaVo® MULTIflex® LUX with water volume adjuster</li> <li>stainless steel body · Titanium coating · LED coupling</li> </ul>
 <p><b>M800KL(NSK) Optic</b></p> <ul style="list-style-type: none"> <li>Power: 23W</li> <li>Speed: 380,000~450,000min<sup>-1</sup></li> <li>Head Size: ø 10.6 x H12.4 mm</li> </ul>  <p><b>M900KL(NSK) Optic</b></p> <ul style="list-style-type: none"> <li>Power: 26W</li> <li>Speed: 325,000~430,000min<sup>-1</sup></li> <li>Head Size: ø 12.1 x H13.3 mm</li> </ul>	<p style="text-align: center;"><b>Scaler</b></p>  <p><b>Varios 170(NSK)</b></p>  <p><b>dmetec(dmetec)</b></p>	

## Option

High Handpiece & Scaler	Angle	Motor
 <p><b>Z900L(NSK) Optic</b></p> <ul style="list-style-type: none"> <li>Power: 26 W, Speed: 320,000~400,000 min<sup>-1</sup></li> <li>Head Size: ø 12.5 x H13.1 mm</li> </ul>	  <p><b>M65/M25(NSK) Non-Optic</b></p> <p><b>M25L(NSK) Optic</b></p> <ul style="list-style-type: none"> <li>stainless steel body · backdraft prevention valve</li> <li>Midwest 4 hole · Max: 25,000 min<sup>-1</sup></li> </ul>  <p><b>M95L(NSK) Optic</b></p> <ul style="list-style-type: none"> <li>4 hole water spray · For FG bur · Ceramic ball bearing</li> <li>Max Speed: 200,000 mi</li> </ul>	 <p><b>M205(NSK)</b></p> <ul style="list-style-type: none"> <li>stainless steel body · backdraft prevention valve</li> <li>Midwest 4 hole</li> <li>Max: 25,000 min<sup>-1</sup></li> </ul>  <p><b>NLX nano(NSK)</b></p> <ul style="list-style-type: none"> <li>System: 180° Vector Control System</li> <li>Type: Sensorless DC Brushless Micromotor</li> <li>Speed: 1,000 - 40,000 min<sup>-1</sup> (NLXBF)</li> <li>Torque: Max. 3.4 Ncm</li> <li>Size: 61g (micromotor only)</li> <li>Light: White LED</li> </ul>

## Specification

Lift System	Hydraulic
Lift Height	490mm~890mm (400mm)
Recline range	0 ° ~70 ° (70 °)
Headrest	Double articulating
Dental light	LED light
Controller	Membrane Keyboard + Color LCD
Spittoon	Manual rotation

## Dimension

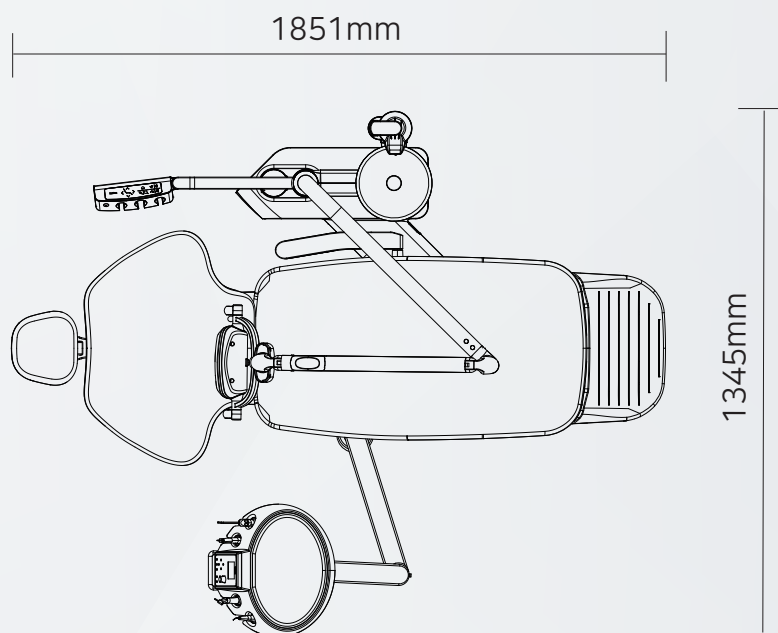

RCB - 2302 (Rev.1) EN